



Model 3142E

BiConiLog™ Antenna



User Manual

PN: 399337

Feb, 2021

Rev C

ETS-Lindgren Inc. reserves the right to make changes to any products herein to improve functioning or design. Although the information in this document has been carefully reviewed and is believed to be reliable, ETS-Lindgren does not assume any liability arising out of the application or use of any product or circuit described herein; nor does it convey any license under its patent rights nor the rights of others. All trademarks are the property of their respective owners.

© Copyright 2012 - 2021 written permission from ETS-Lindgren Inc. All Rights Reserved. No part of this document may be copied by any means without written permission from ETS-Lindgren Inc.

Trademarks used in this document: The *ETS-Lindgren* logo is a registered trademark of ETS-Lindgren, Inc.; *Teflon* is a registered trademark of E. I. du Pont de Nemours and Company or its affiliates.

Revision Record

MANUAL, 3142E | Part # 399337 Rev C

Revision	Description	Date
A	Initial Release	July, 2012
B	Updated frequency range; updated boom options	February, 2015
C	Updated manual format and added typical data for cross polarization	February, 2021

TABLE OF CONTENTS

NOTES, CAUTIONS AND WARNINGS	4
INTRODUCTION	5
Tripod Options6
ETS-Lindgren Product Information Bulletin6
MAINTENANCE	7
Replacement and Optional Parts7
Service Procedures7
Contacting ETS-Lindgren7
Sending a Component for Service7
Calibration Services and Annual Calibration7
SPECIFICATIONS	8
Electrical Specifications8
ASSEMBLY	9
Attach Bowtie Elements9
MOUNTING	11
Using Included Mounting Adapters	11
Using the Stinger to Mount to a Model 2175 MiniMast	12
Additional Mounting Options	14
4-TR Mounting Options	14
7-TR and Mast Mounting Options	15
2X2 Boom Mounting Options	16
TYPICAL DATA	17
Typical Antenna Factor and Gain	17
Typical VSWR	18
Typical Half Power Beamwidth	18
Typical Radiation Patterns	19
30MHz-50MHz	19
70MHz-90MHz	19
100 MHz-200MHz	20
300MHz-400MHz	20
500MHz-600MHz	21

700MHz-800MHz	21
900MHz-1000MHz	22
2000MHz-3000MHz	22
4000MHz-5000MHz	23
6000MHz	23
Typical Cross Polarization	24

APPENDIX A: WARRANTY

NOTES, CAUTIONS AND WARNINGS

	Note: Denotes helpful information intended to provide tips for better use of the product.
CAUTION	CAUTION: Denotes a hazard. Failure to follow instructions could result in minor personal injury and/or property damage. Included text gives proper procedures.
WARNING	WARNING: Denotes a hazard. Failure to follow instructions could result in SEVERE personal injury and/or property damage. Included text gives proper procedures.

*All notes, cautions, and warnings will be located on the left column area of the page.



See the ETS-Lindgren **Product Information Bulletin** for safety, regulatory, and other product marking information

INTRODUCTION

The ETS-Lindgren **Model 3142E BiConiLog™ Antenna** is designed as a dual-purpose antenna that can be used for both immunity and emission testing. From 30 MHz to 6 GHz, the Model 3142E exhibits an average 5.5 dB gain. Applications for the Model 3142E include emissions testing, immunity measurements, and medical equipment testing.



Model 3142E shown in vertical polarization

The Model 3142E Antenna includes a stinger mount; it also includes a mounting bracket and a 1/4–20 thread knob to attach to an ETS-Lindgren tripod or tower adapter.

For the variety of mounting options available for the Model 3142E, see Mounting instructions.

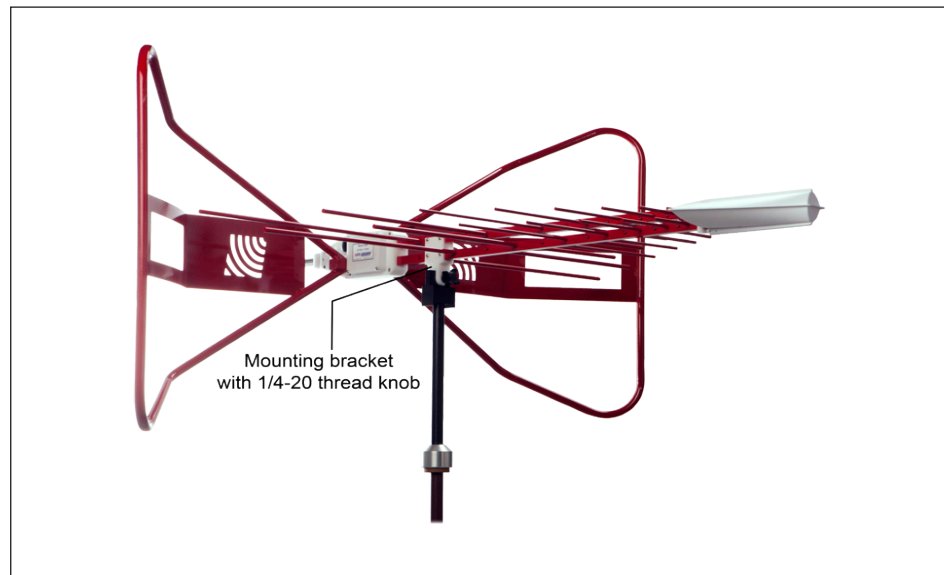

Model 3142E shown in horizontal polarization



Note:

For easy horizontal and vertical polarization, the ETS-Lindgren Model 7-TR tripod is recommended.

Tripod Options

ETS-Lindgren offers the following non-metallic, non-reflective tripods for use at both indoor and outdoor EMC test sites.

- 4-TR Tripod—Constructed of linen phenolic and delrin, designed with an adjustable center post for precise height adjustments. Maximum height is 2.0 m (80.0 in), and minimum height is 94 cm (37.0 in). This tripod can support up to an 11.8 kg (26.0 lb) load.



- 7-TR Tripod—Constructed of PVC and fiberglass components, providing increased stability for physically large antennas. The unique design allows for quick assembly, disassembly, and convenient storage. Allows several different configurations, including options for manual or pneumatic polarization. Quick height adjustment and locking wheels provide ease of use during testing. Maximum height is 2.17 m (85.8 in), with a minimum height of 0.8 m (31.8 in). This tripod can support a 13.5 kg (30 lb) load.



ETS-Lindgren Product Information Bulletin

See the ETS-Lindgren *Product Information Bulletin* included with your shipment for the following:

- Safety, regulatory, and other product marking information
- Steps to receive your shipment
- Steps to return a component for service
- ETS-Lindgren calibration service
- ETS-Lindgren contact information

CAUTION

Before performing any maintenance, follow the safety information in the ETS-Lindgren Product Information Bulletin included with your shipment.

WARNING

Maintenance of the Model 3142E is limited to external components such as cables or connectors.



If you have any questions concerning maintenance, contact ETS-Lindgren Customer Service.



Note:

ETS-Lindgren may substitute a similar part or new part number with the same functionality for another part/part number. Contact ETS-Lindgren for questions about part numbers and ordering parts.

For additional/optional mounting hardware, see Additional Mounting Options.

MAINTENANCE

Replacement and Optional Parts

The following are the part numbers for ordering replacement or optional parts for the Model 3142E.

Part Description	Part Number
Polarizing Mounting Adapter	100989
Thread Insert	105861

Service Procedures

Contacting ETS-Lindgren

Please see www.ets-lindgren.com for a list of ETS-Lindgren offices, including phone and email contact information.

Sending a Component for Service

For the steps to return a system or system component to ETS-Lindgren for service, see the Product Information Bulletin included with your shipment.

Calibration Services and Annual Calibration

See the Product Information Bulletin included with your shipment for information on ETS-Lindgren calibration services.

SPECIFICATIONS

Electrical Specifications

Frequency Range:	30 MHz–6 GHz		
Input Impedance (Nominal):	50 Ω		
VSWR (Average):	2:1 above 50 MHz		
Maximum Continuous Power		Continuous	Peak
	30 MHz-60 MHz:	500 W	800 W
	60 MHz-600 MHz:	1 kW	1.5 kW
	600 MHz-1 GHz:	500 W	800 W
	1 GHz-6 GHz:	200 W	300 W
Peak Power:	1.3 kW		
Pattern Type:	Directional		
Polarization:	Linear		
Connector:	Type N female		

Physical Specifications

Height (Overall):	76.2 cm (30 in)
Length:	139.16 cm (54.79 in)
Width:	133.75 cm (52.66 in)
Weight:	5.7 kg (12.5 lb)

ASSEMBLY

CAUTION

Before connecting any components, follow the safety information in the ETS-Lindgren Product Information Bulletin included with your shipment.

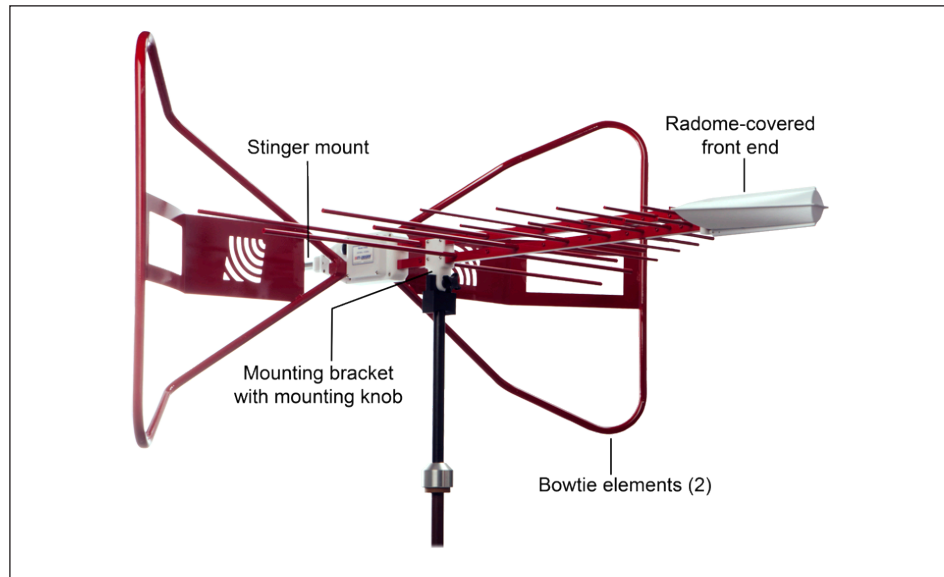

Model 3142E shown in vertical polarization

The Model 3142E BiConiLog™ Antenna is comprised of the following parts:

- Antenna
- Bowtie elements (2)
- 10–32 thumbscrew knobs to attach bowtie elements (2)
- Mounting bracket and mounting knob

Attach Bowtie Elements

The Model 3142E ships with the bowtie elements detached. To attach the bowtie elements:

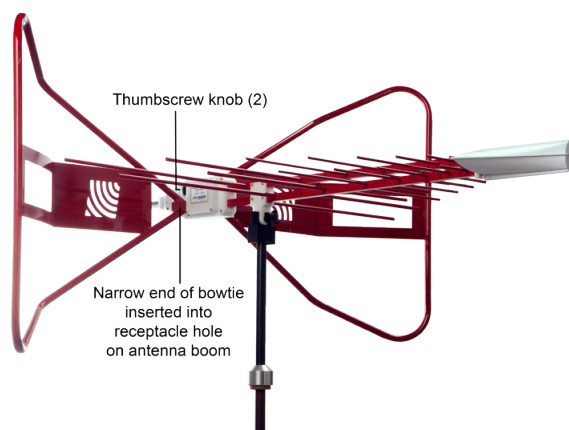

Note:

Photos of bowtie elements used in this section may differ from the bowtie elements for your Model 3142E; the assembly procedure is the same for both.

1. For stability, mount the Model 3142E onto a tripod or tower. See Mounting Instructions on page 19 for the steps to mount the antenna.

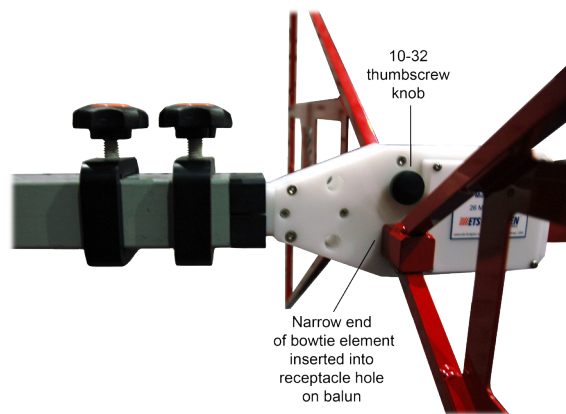

CAUTION

Do not cross thread this connection or permanent damage to the bowtie element could occur.

2. Slide the narrow end of one of the bowtie elements into the receptacle hole on the antenna balun, and then align the bowtie with the receptacle on the balun.
3. Insert one of the 10–32 thumbscrew knobs into the opposite side of the balun from where you inserted the bowtie. Slowly tighten the knob, taking care not to cross thread the connection.
4. Repeat steps 2 and 3 for the second bowtie element.

MOUNTING

CAUTION

Before connecting any components, follow the safety information in the ETS-Lindgren Product Information Bulletin included with your shipment.

The Model 3142E antenna is a precision measurement device. Handle with care.



Note:

Photos of bowtie elements used in this section may differ from the bowtie elements for your Model 3142E; the assembly procedure is the same for both.

Contact with any metal or non-metallic structure can capacitively load the antenna, which may cause unrepeatable results. Therefore, make sure that no part of the dipole elements or bowties is in contact with the tripod or tower, particularly in vertically-polarized tests. Where possible, run the feed cable straight one meter or more back from the Model 3142E BiConiLog™ Antenna before dropping vertically.

Using Included Mounting Adapters

In addition to the attached mounting bracket and mounting knobs, the Model 3142E ships with these mounting adapters:

1. 100989 Polarizing Mounting Adapter with 7/8-14 thread receptacle

- If you need to convert the polarizing adapter to a 1/4-20 receptacle, insert the 1/4-20 thread insert into the polarizing adapter

2. 105861 1/4-20 Thread Insert

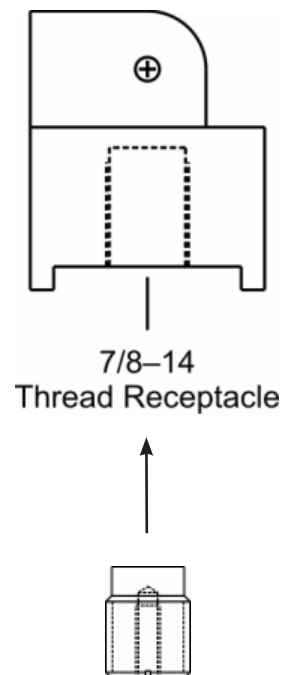

To attach the included adapters to the Model 3142E:

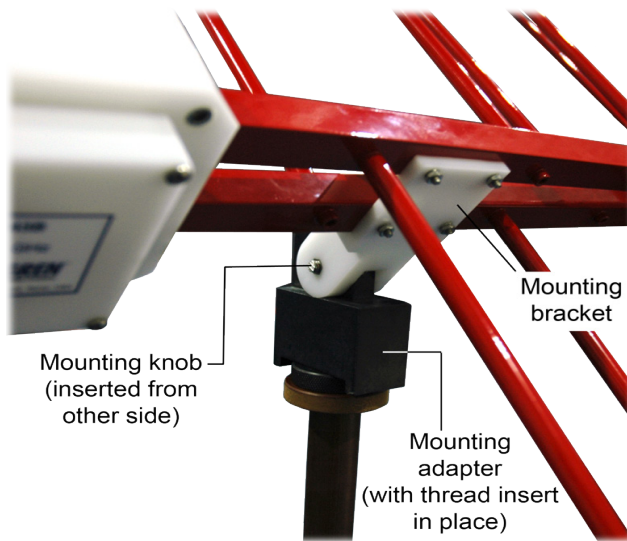

Model 3142E mounted onto 4-TR using included 100989 Polarizing Mounting Adapter and 105861 1/4-20 Thread Insert

CAUTION

Do not cross thread or permanent damage to the adapter and thread insert could occur.

1. If required, insert the 1/4-20 thread insert into the mounting adapter.
2. Remove the mounting knob from the mounting bracket on the antenna.
3. Slide the mounting bracket onto the mounting adapter with the adapter placed between the shoulders of the mounting bracket.
4. Thread the mounting knob through the mounting bracket, then through the mounting adapter, and finally through the hex nut.
5. Tighten the mounting knob to secure the antenna.
6. Attach the mounting adapter and antenna to tripod or tower, as required.

Using the Stinger to Mount to a Model 2175 MiniMast

The stinger mount provides on-axis rotation during 90° horizontal or vertical polarization. The stinger enables you to mount the antenna directly to an ETS-Lindgren 7-TR Tripod or mast.



Note:

Do not use the stinger to mount the Model 3142E onto a 4-TR tripod.

Before you begin –

- Install the center rotate boom (part# 108507) for rear-mount stinger-type antennas.
- Attach the included mounting adapter to the Model 3142E as instructed in Using Included Mounting Adapters on page 20.
- You will need one of the optional mounting knobs described in 7-TR and Mast Mounting Options on page 26. To order optional mounting hardware, contact the ETS-Lindgren Sales Department.

CAUTION

Before connecting any components, follow the safety information in the ETS-Lindgren Product Information Bulletin included with your shipment.

The Model 3142E antenna is a precision measurement device. Handle with care.



Note:

Photos of bowtie elements used in this section may differ from the bowtie elements for your Model 3142E; the assembly procedure is the same for both.

1. Thread the antenna feed or receiving cable through the center of the boom so that the antenna connector emerges a few inches out of the clamp end of the boom.

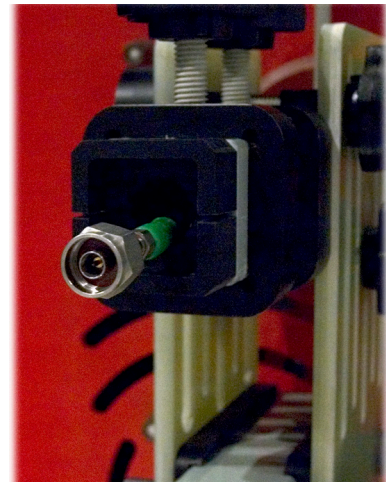

2. Attach the cable to the Type N connector at the end of the stinger.

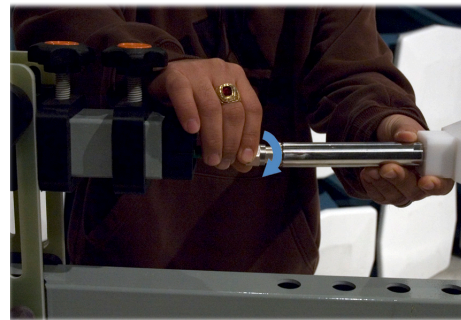

3. Slide the cable and stinger into the clamp on the boom, carefully guiding the cable out the other end.

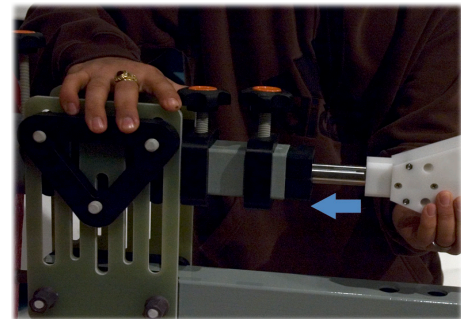

4. When you reach the back of the balun box, align it with the boom receptacle, and then slide the smaller portion of the balun box into the boom. This will prevent rotation of the antenna unless the boom is being polarized.

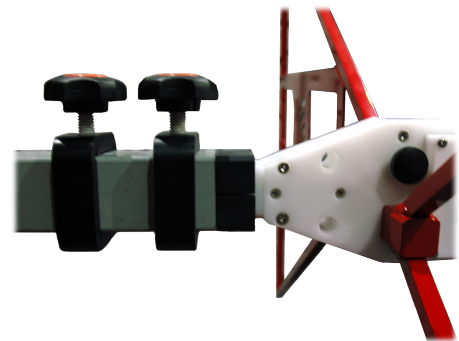

- Tighten the clamp knobs on the boom to secure the antenna into place.

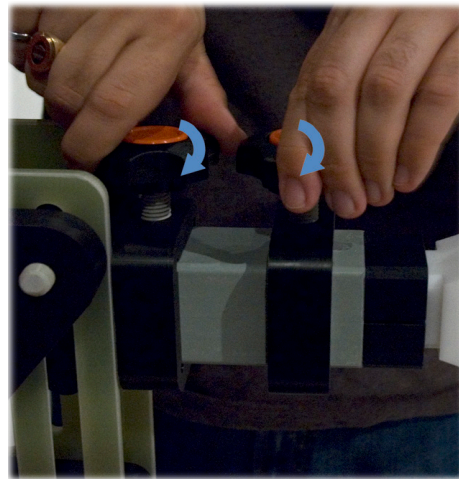

Additional Mounting Options

4-TR Mounting Options

Following are additional options for mounting the Model 3142E onto an ETS-Lindgren 4-TR tripod. Contact the ETS-Lindgren Sales Department for information on ordering optional mounting hardware.

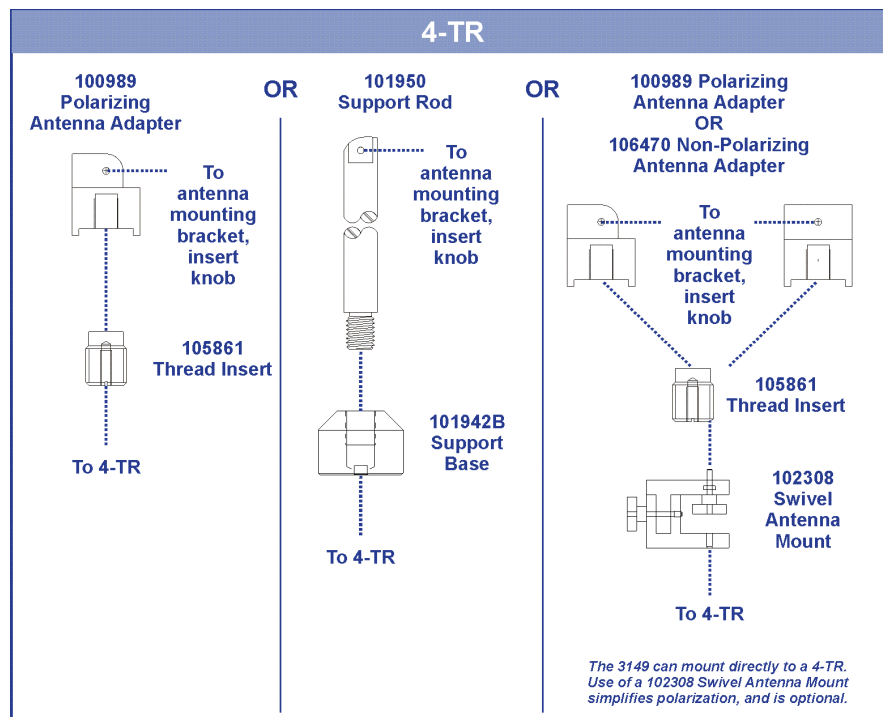

7-TR and Mast Mounting Options

The stinger on the Model 3142E enables you to mount to antenna directly to an ETS-Lindgren 7-TR Tripod Positioner.

However, following are additional options for mounting the Model 3142E onto an ETS-Lindgren 7-TR Tripod Positioner.

Contact the ETS-Lindgren Sales Department for information on ordering optional mounting hardware.

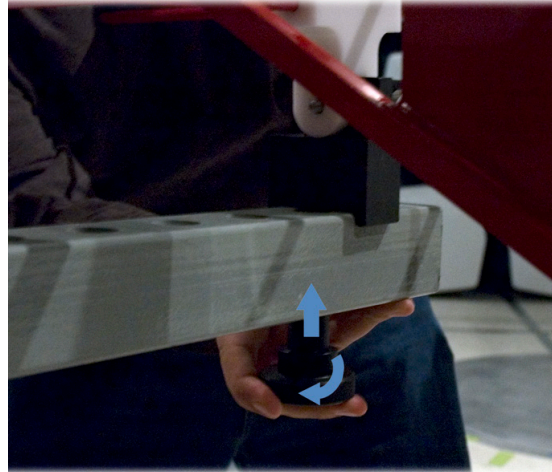

Non-stinger method to mount Model 3142E to 7-TR



Note:

Mast refers to 2070 Series, 2075, and 2175 Antenna Towers.

7-TR refers to these booms –

- 109042 boom—Straight boom; for general antenna mounting on a 7-TR
- 108983 boom—Offset boom; for general antenna mounting on a 7-TR with pneumatic or manual polarization; can also be used to mount stinger-type antennas
- 118947 – for stinger-type antennas only

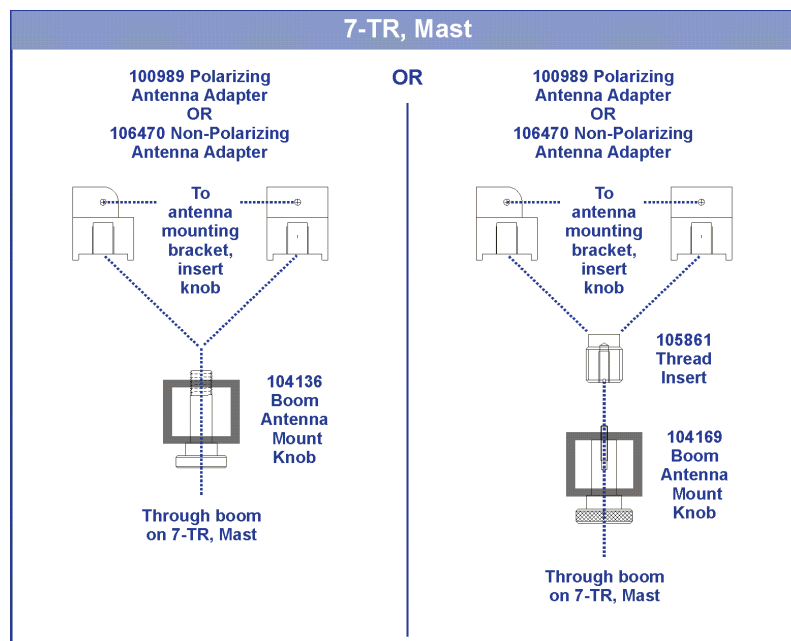



Note:

2x2 boom refers to a typical 2-inch by 2-inch boom.

2X2 Boom Mounting Options

Following are additional options for mounting the Model 3142E onto a 2x2 boom. Contact the ETS-Lindgren Sales Department for information on ordering optional mounting hardware.

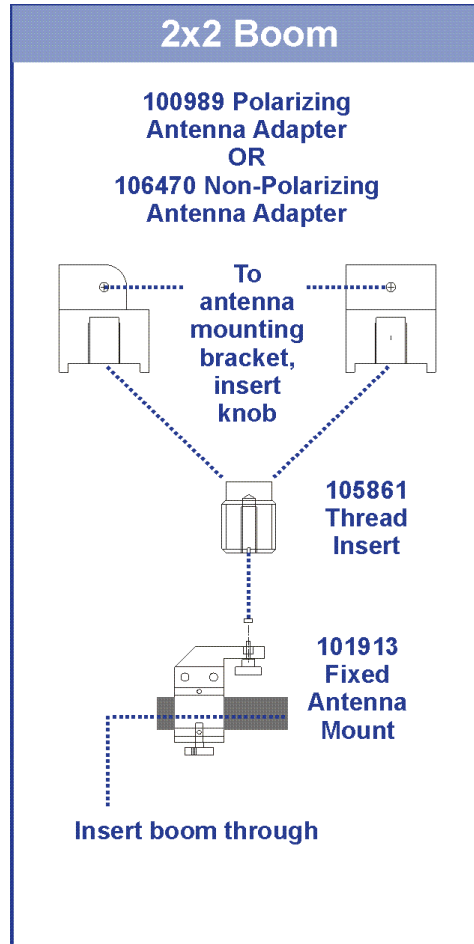

TYPICAL DATA

Typical Antenna Factor and Gain

Distance for the ANSI 3-meter and 10-meter calibrations is measured from the antenna midpoint, and for SAE 1-meter calibrations the distance is measured from the antenna tip. Midpoint is defined as half the distance between the small elements and the bowties, which is about 45 cm from the small end tip.

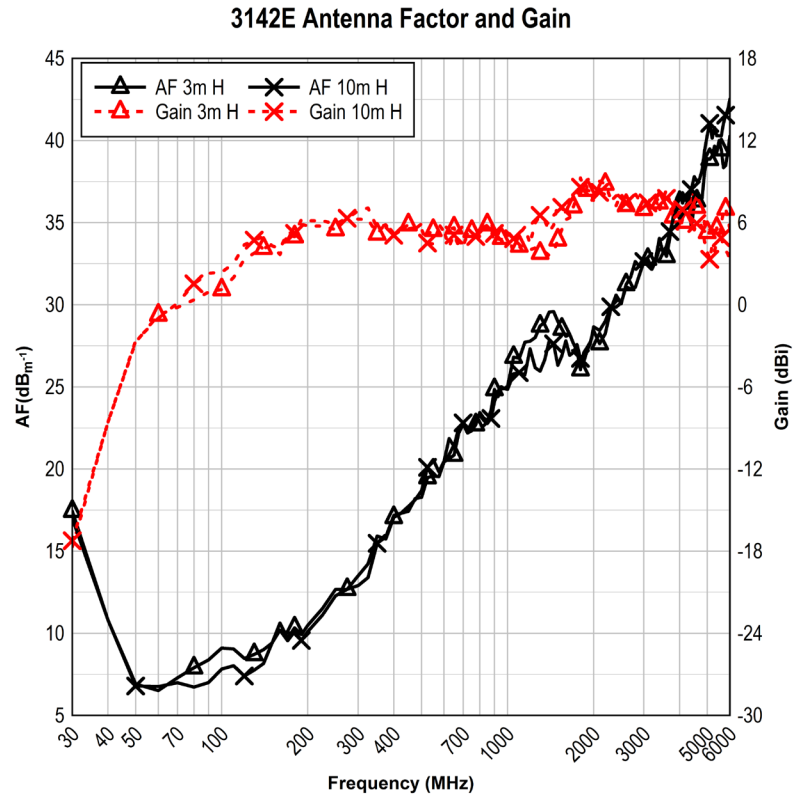

Typical VSWR

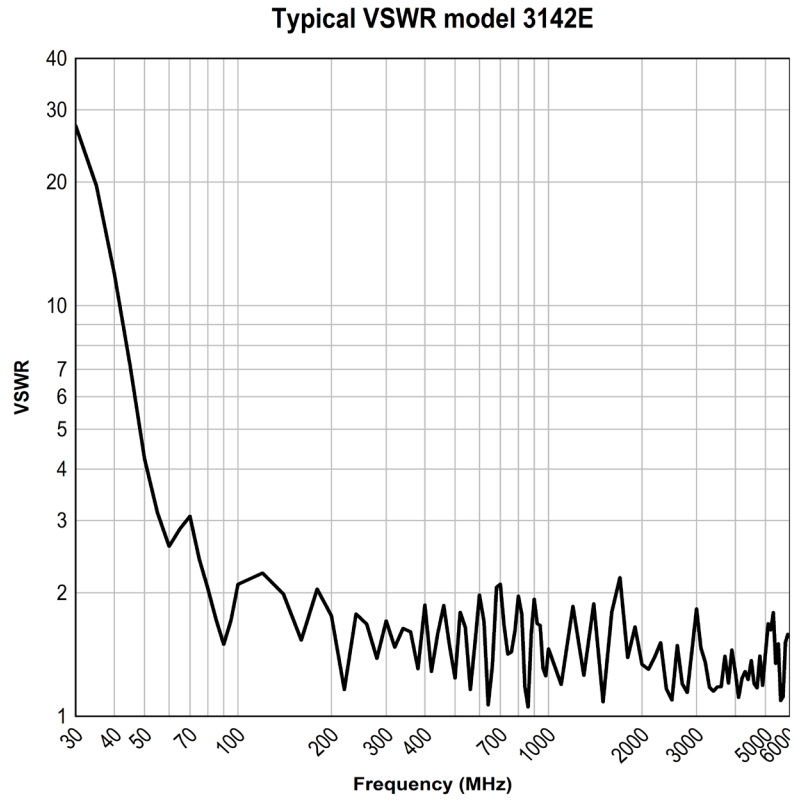

Typical Half Power Beamwidth

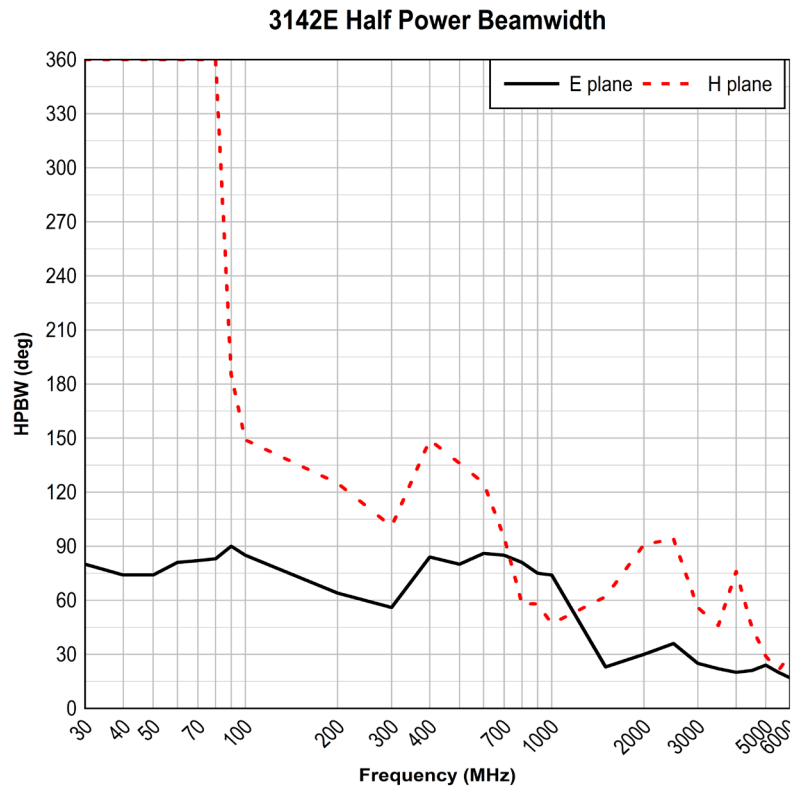

Typical Radiation Patterns

30MHz-50MHz

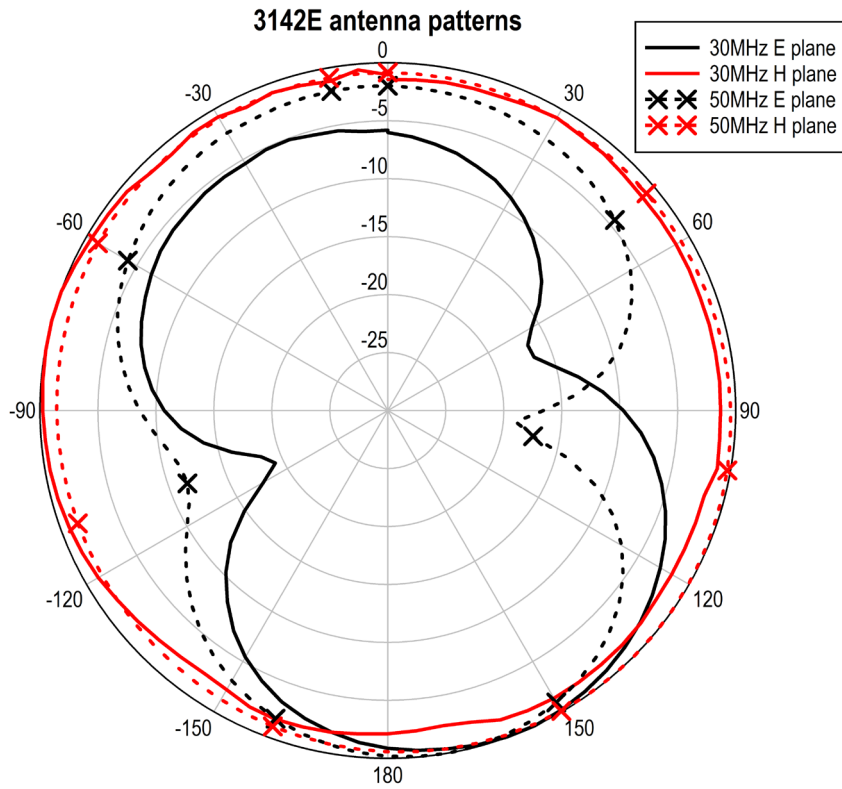

70MHz-90MHz

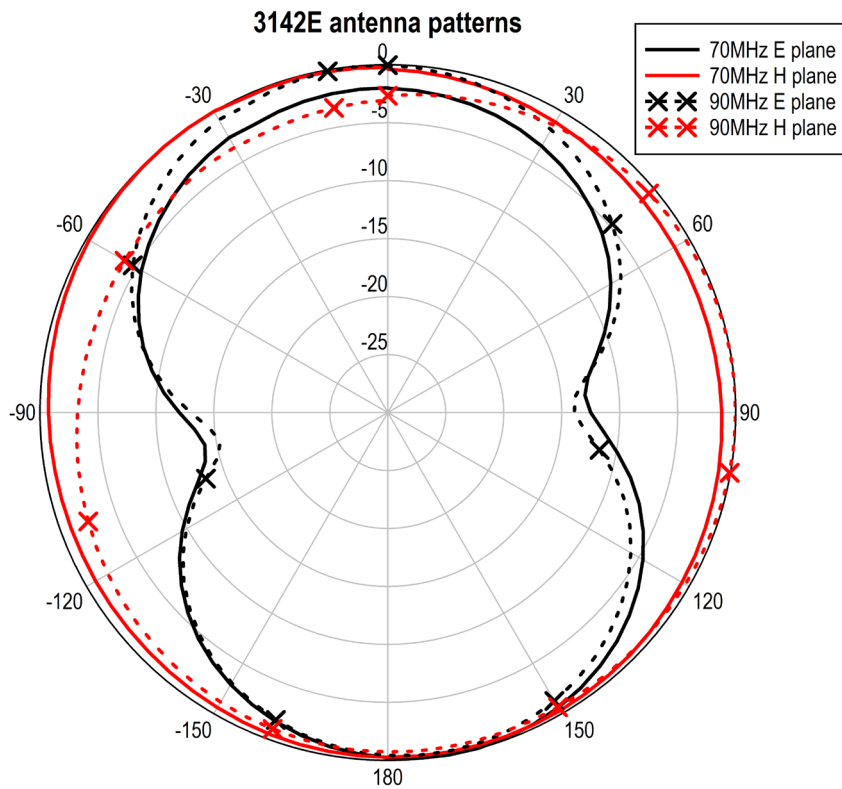

100 MHz-200MHz

3142E antenna patterns

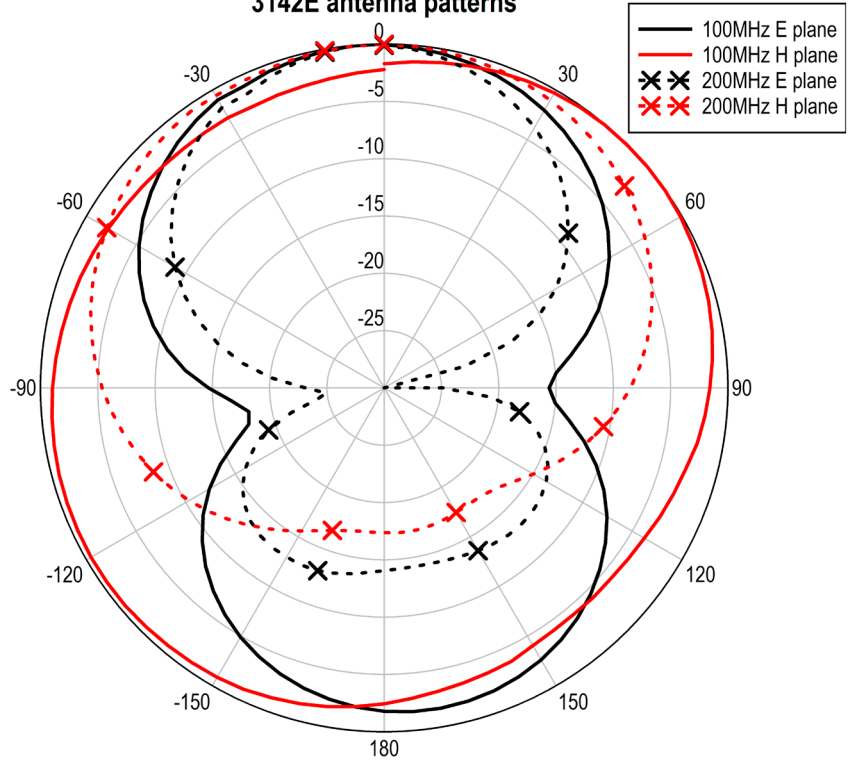

300MHz-400MHz

3142E antenna patterns

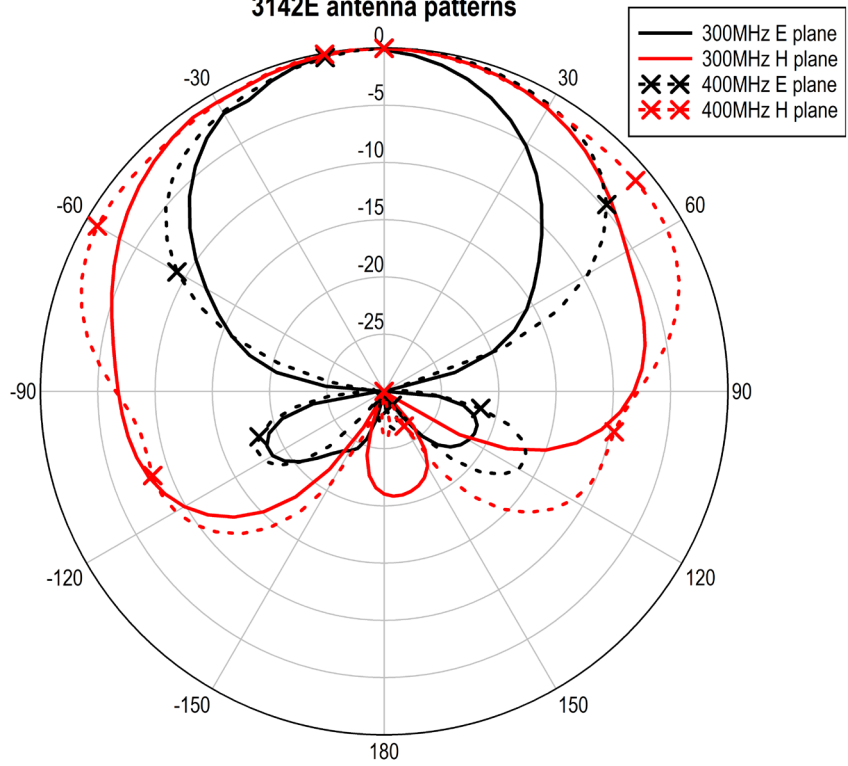

500MHz-600MHz

3142E antenna patterns

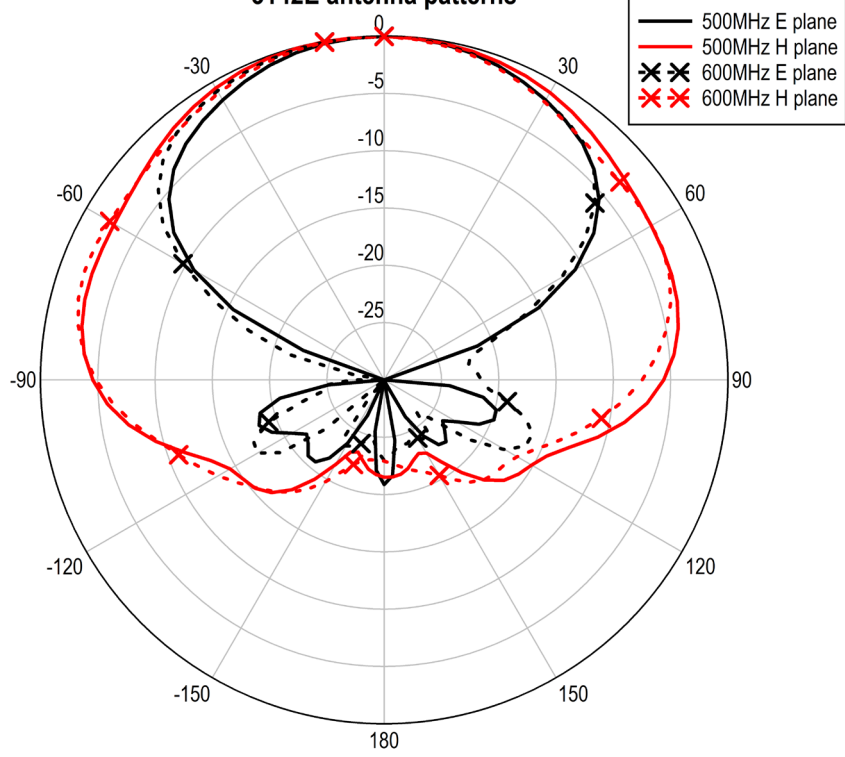

700MHz-800MHz

3142E antenna patterns

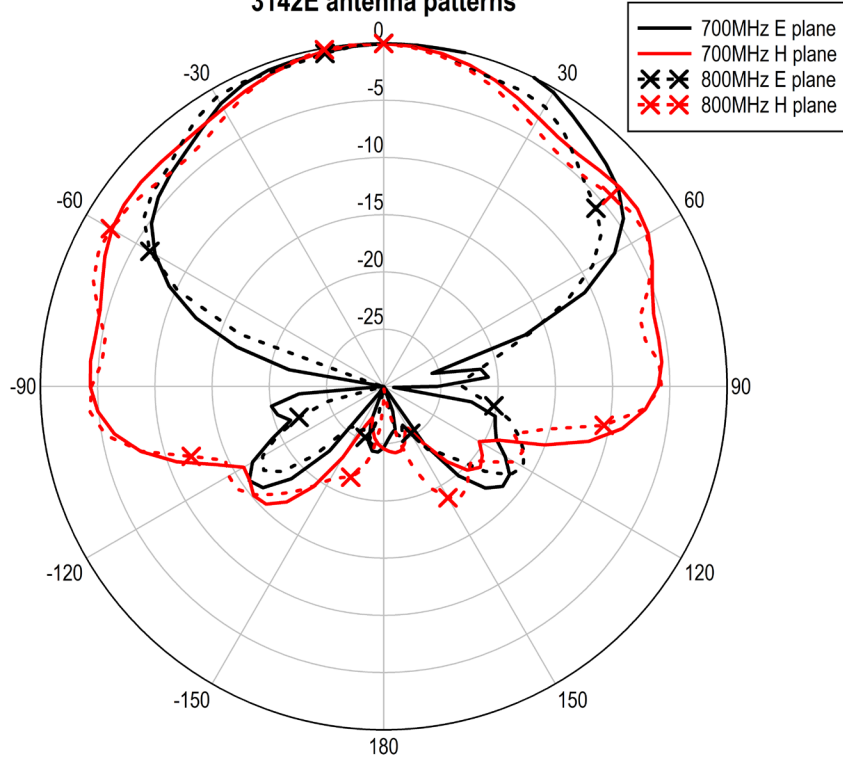

900MHz-1000MHz

3142E antenna patterns

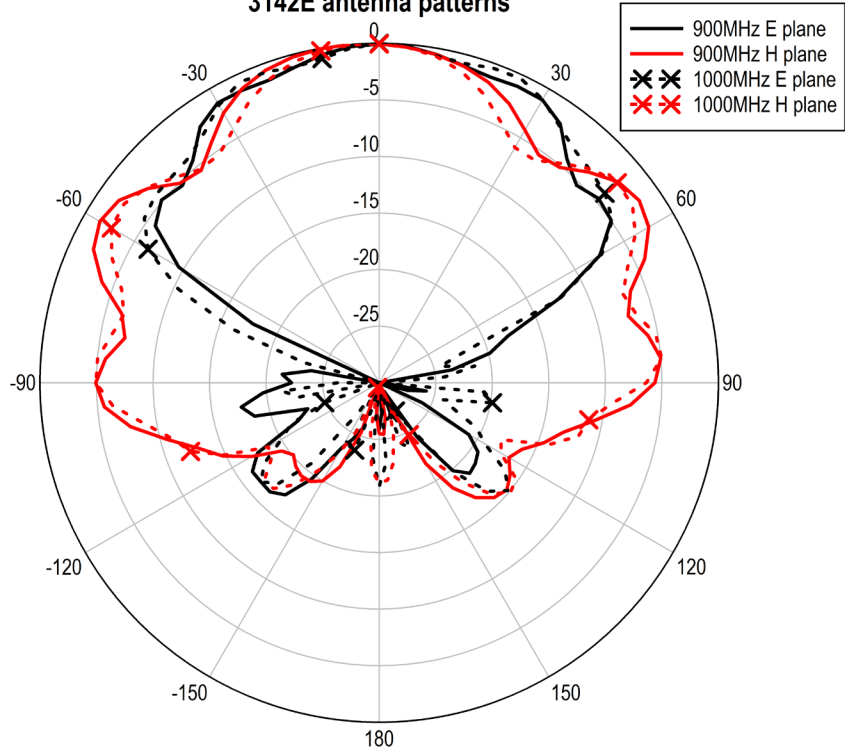

2000MHz-3000MHz

3142E antenna patterns

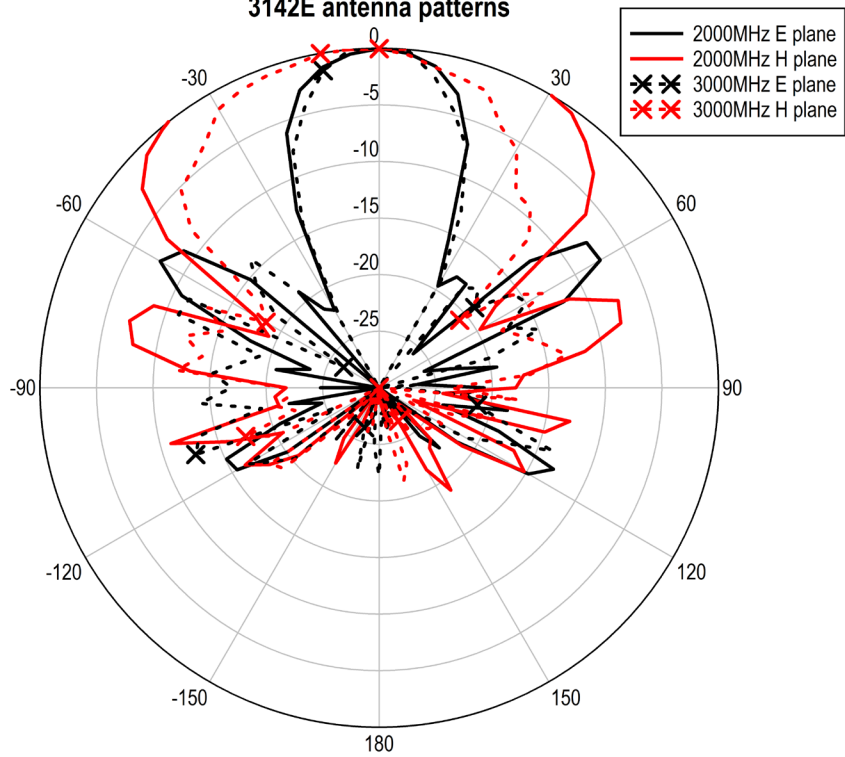

4000MHz-5000MHz

3142E antenna patterns

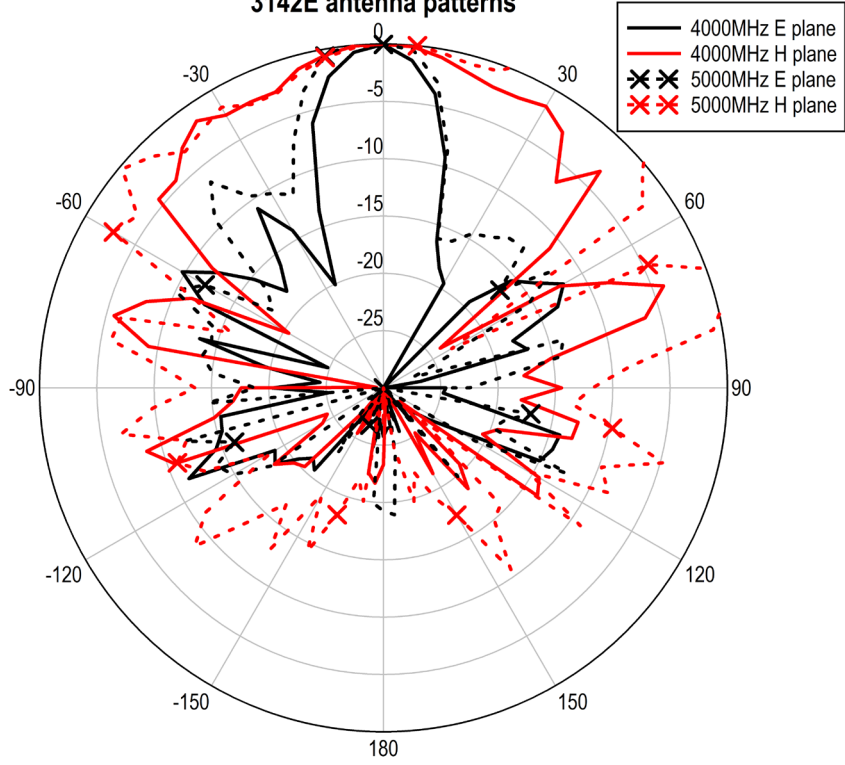

6000MHz

3142E antenna patterns

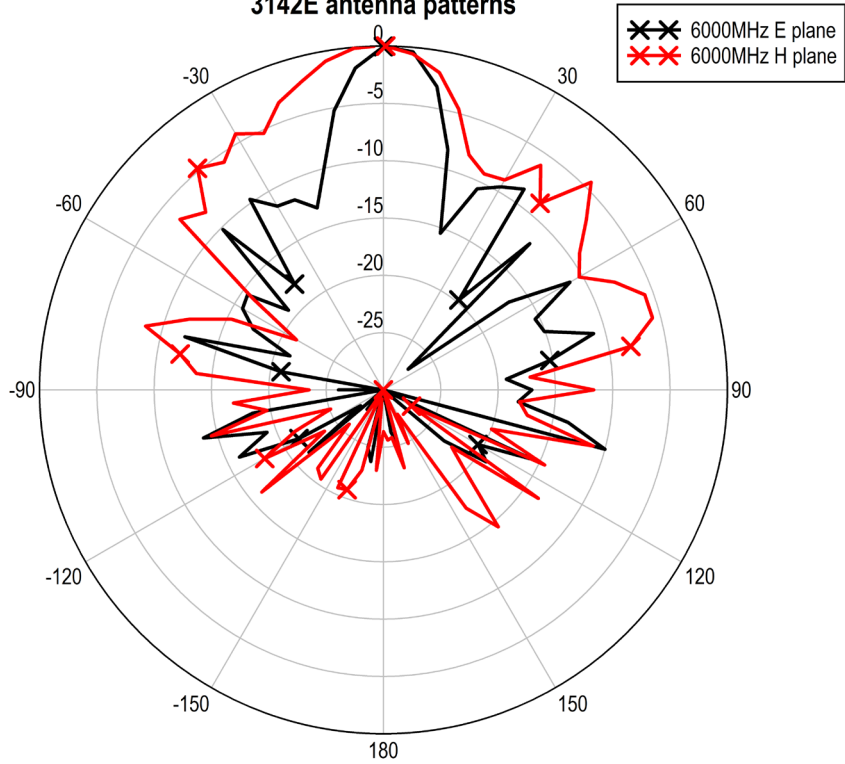

Typical Cross Polarization

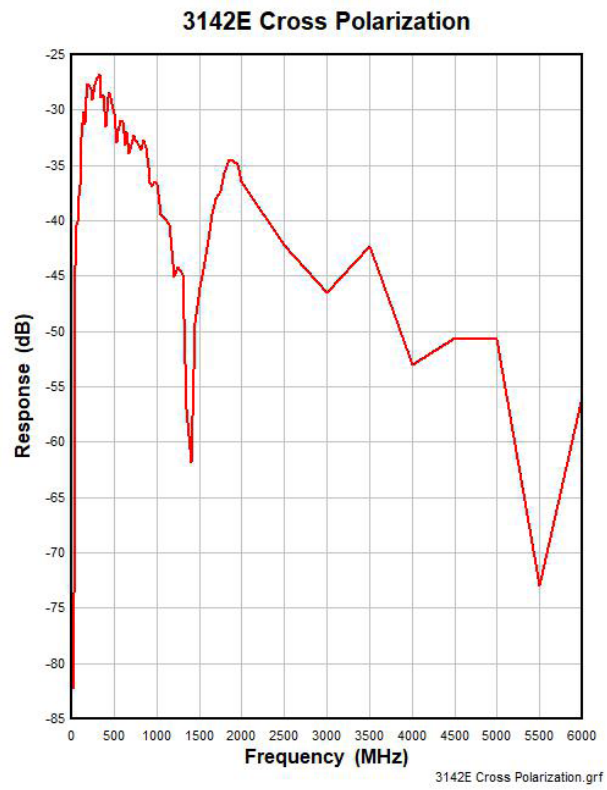

APPENDIX A: WARRANTY

See the Product Information Bulletin included with your shipment for the complete ETS-Lindgren warranty for your Model 3142E BiConiLog™ Antenna.

